

1

2

3

4

Technical sheet / Datos técnicos:

Part number adaptable to / Referencia adaptable a	LA8637
Opening pressure of safety valve / Presión de apertura válvula de seguridad	13 bar
Unloader / Regulador de presión	Integrated / Integrado
Cut-out pressure / Presión de corte	10,4 ± 0,2 bar
Heating / Calentador	100 W/ 24 V
Cut-in temperature / Temperatura de cierre	+7 ± 6 °C
Cut-off temperature / Ajuste de la temperatura	+29,5 ± 3 °C
Permissible medium / Medio de funcionamiento	Air / Aire
Operating temperature range / Rango de temperatura	-40 °C to / a +80 °C
Weight / Peso	2050 gr

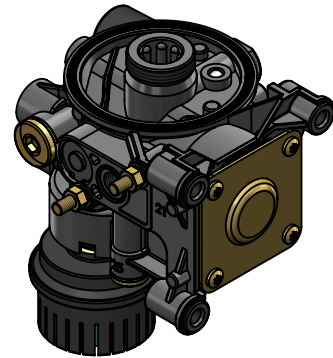
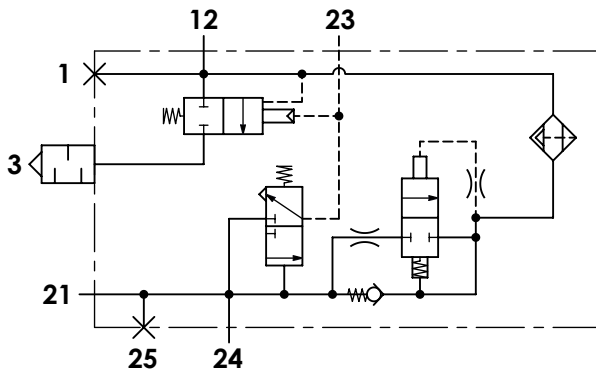

Port / Conexión	Function / Función	Thread / Rosca
1	Supply from air compressor / Alimentación desde el compresor	Closed / Taponada
12	External filling / Llenador exterior	M22x1,5
21	Delivery to protection valve / Salida a válvula de protección	M16x1,5
23	Control to air compressor / Pilotaje al compresor	M16x1,5
24	Auxiliar output / Salida auxiliar	M22x1,5
25	Auxiliar output / Salida auxiliar	Closed / Taponada
3	Exhaust / Escape	Silencer / Silencioso
6	Heating / Calentador	Bayonet DIN 72585 A1-2

Purpose / Propósito:

Drying of the compressed air supplied by the compressor. / Secado del aire comprimido procedente del compresor.

Installation requirements / Requisitos para la instalación:

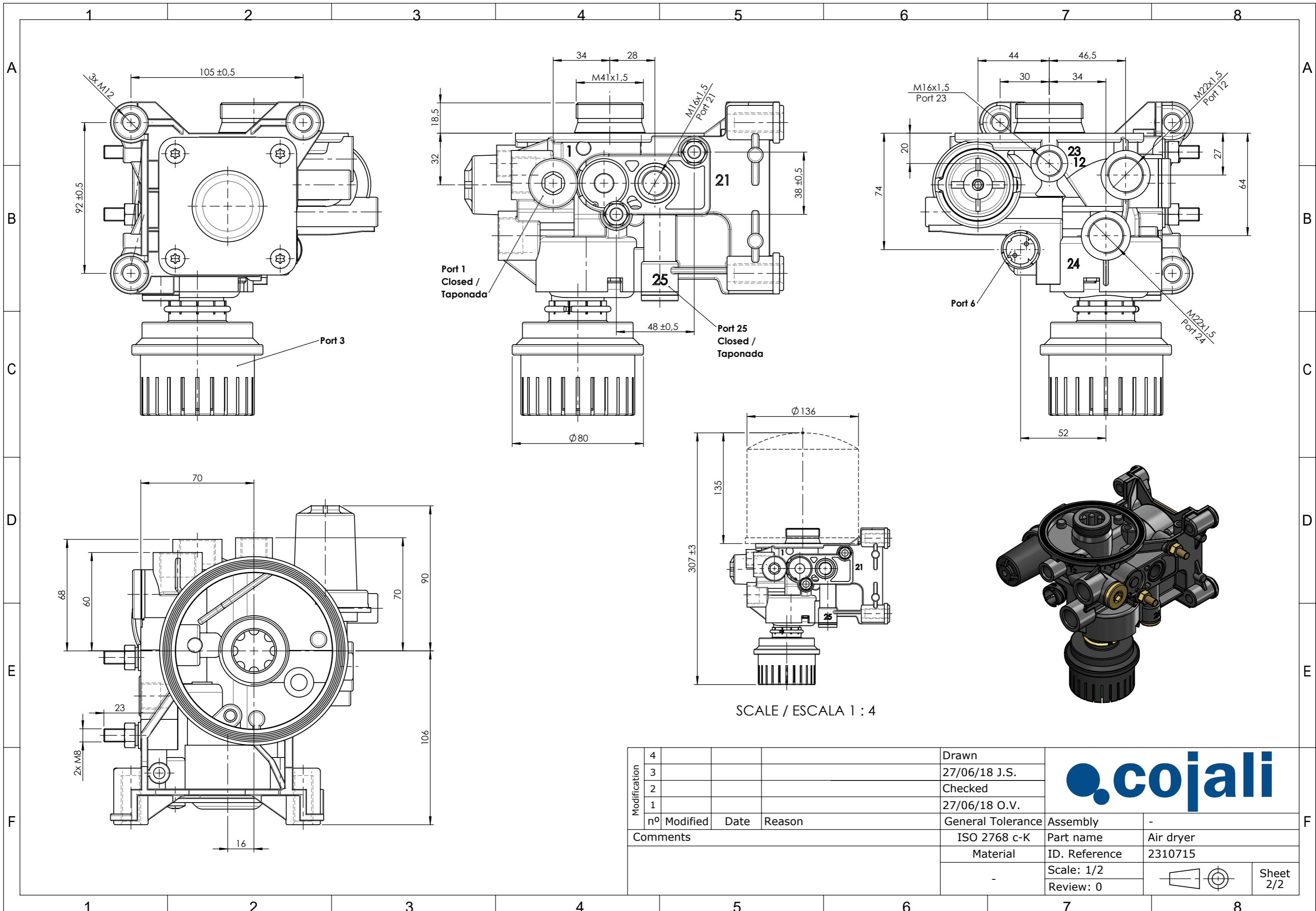

Exhaust (3) must look down. / El escape (3) debe estar orientado hacia abajo.

Modification	4				Drawn		
	3				27/06/18 J.S.		
	2				Checked		
	1				27/06/18 O.V.		
	nº	Modified	Date	Reason	General Tolerance		Assembly
Comments					-	Part name	Air dryer
					Material	ID. Reference	2310715
					-	Scale: -	
					-	Review: 0	

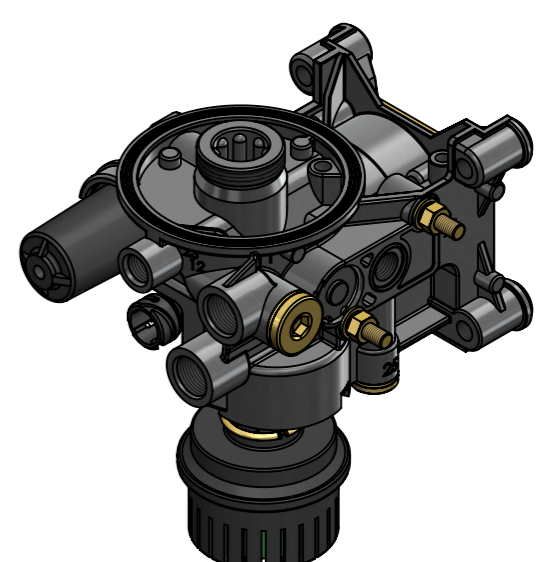

SCALE / ESCALA 1 : 4



Modification	4			Drawn	
	3			27/06/18 J.S.	
	2			Checked	
	1			27/06/18 O.V.	
	nº Modified	Date	Reason	General Tolerance	Assembly
Comments				ISO 2768 c-K	Part name
				Material	ID. Reference
				-	Scale: 1/2
					Review: 0
					 
					Sheet 2/2