





Technical sheet / Datos técnicos:

Part number adaptable to / Referencia adaptable a	4710035300
Operating pressure / Presión de trabajo	max. 5.3 bar
Predominance / Predominancia	-
Permissible medium / Medio de funcionamiento	Air / Aire
Operating temperature range / Rango de temperatura	-40 °C to / a +80 °C
Weight / Peso	1600 gr

Pressure regulation / Regulación de presión

Symbol / Símbolo	Description / Descripción	Range of adjustment / Rango de ajuste (bar)	Adjusted to / Ajustado a (bar)
	Release position / Posición de reposo		
	Empty position / Posición vacío	0.8 ... 2.2	1.6 (-0.2)
	Half load position / Posición media carga	2.8 ... 3.7	3.4 (-0.2)
	Full load position / Posición carga completa		

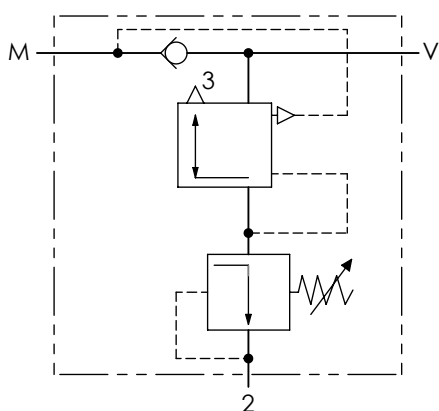

Port / Conexión	Function / Función	Thread / Rosca
M	Supply / Alimentación	M22x1.5
V	Reservoir supply / Suministro del depósito	M22x1.5
2	Delivery / Salida	M22x1.5
3	Exhaust / Escape	-

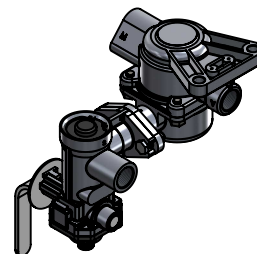

Purpose / Propósito: Control of single-line air braking system of trailer when the braking system of the towing vehicle is actuating. Triggering of the automatic semitrailer braking with partial or total pressure drop in the supply line. / Control de la línea doble de freno del trailer cuando actúa el sistema de freno del vehículo tractor. Activación del freno automático del semitrailer con total o parcial caída de presión en la línea de alimentación.

Installation requirements / Requisitos para la instalación: Install the trailer brake valve vertically with the exhaust pointing downward. Fasten the trailer brake valve with two M10 bolts. / Instalar la válvula de freno de trailer verticalmente con el escape apuntando hacia abajo. Fijar la válvula de freno de trailer con dos tornillos M10.

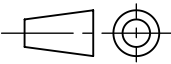
Modification				Drawn			
	nº	Modified	Date	Reason	General Tolerance		
4					Assembly		-
3					Part name		Relay emergency valve
2					ID. Reference		2226102
1					Scale: -		
					Review: 0		Sheet 1/2

