

1

2

3

4

Technical sheet / Datos técnicos:

Part number adaptable to / Referencia adaptable a	9347130370
Operating pressure / Presión de trabajo	max. 11 bar
Permissible medium / Medio de funcionamiento	Air / Aire
Operating temperature range / Rango de temperatura	-40°C to / a +90°C
Weight / Peso	700 gr

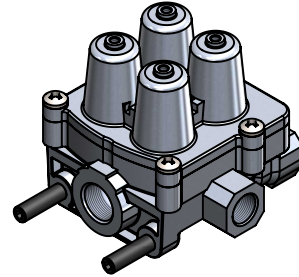
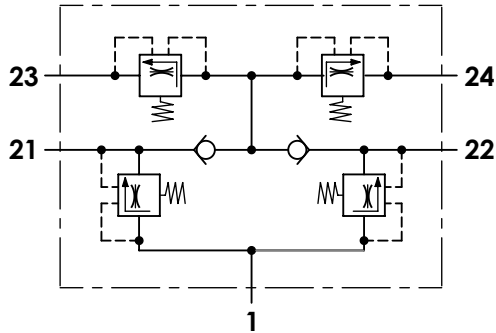

Port / Conexión	Function / Función	Thread / Rosca
1	Supply / Alimentación	1/2"-14 P.T.F
21	Delivery / Salida	3/8"-18 P.T.F
22	Delivery / Salida	3/8"-18 P.T.F
23	Delivery / Salida	3/8"-18 P.T.F
24	Delivery / Salida	3/8"-18 P.T.F

Circuit / Circuito	1	2	3	4
Port / Conexión	21	22	23	24
Opening pressure / Presión de apertura (bar)	6,2 ⁰ _{-0,3}		6,2 ⁰ _{-0,3}	
Closing pressure dynamic / Presión de cierre dinámica (bar)	≥ 4,8		≥ 4,8	

Purpose / Propósito:

To distribute clean and dry air from the air dryer to different pneumatic circuits. Ensure pressure in brake circuits in case of leaks or breakage in any circuit./ Distribuir el aire limpio y seco proveniente del secador a los diferentes circuitos neumáticos. Asegurar la presión en los circuitos de freno en caso de fuga o rotura en cualquier circuito.

Installation requirements / Requisitos para la instalación:

The protection valve may be installed into the piping in any position. Mounting is accomplished by using two studs M8. / La válvula de protección puede instalarse en las tuberías en cualquier posición. El montaje se realiza mediante dos espárragos M8.

Modification	4				Drawn		
	3				29/08/13 O.V.		
	2				Checked		
	1	J.S.	02/06/21	Change of sheet format	29/08/13 A.L.		
	nº	Modified	Date	Reason	General Tolerance		Assembly
Comments					Part name	Protection circuit valve	
					Material	ID. Reference	2222435
					Scale: -		Sheet 1/2
				Review: 1			

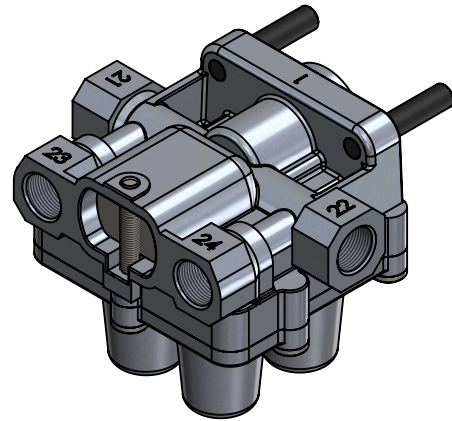
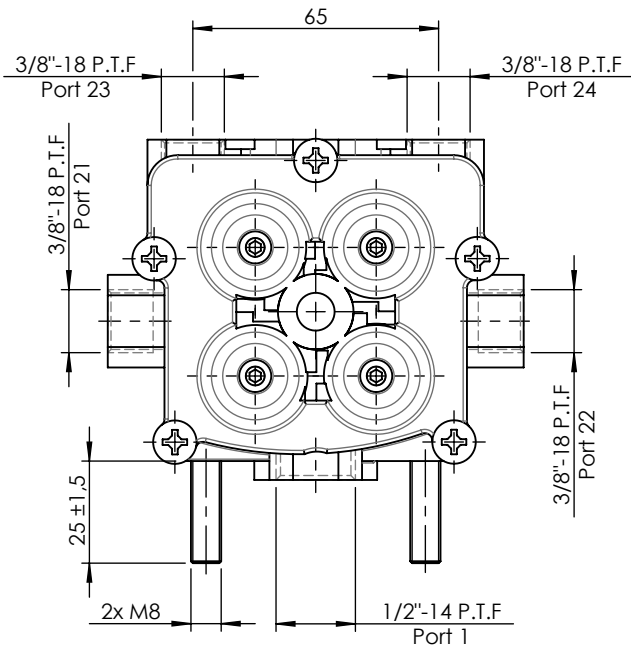
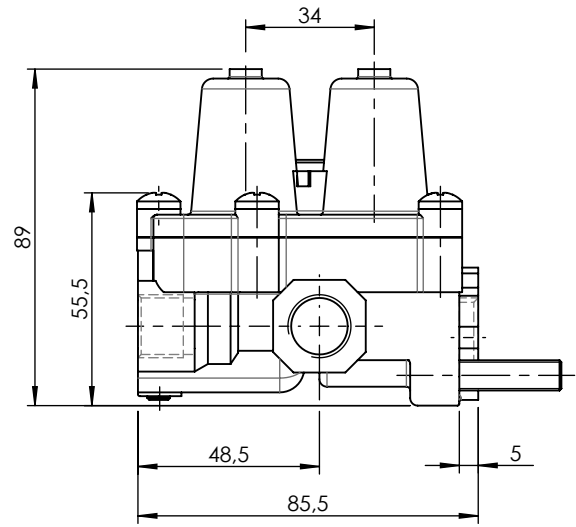
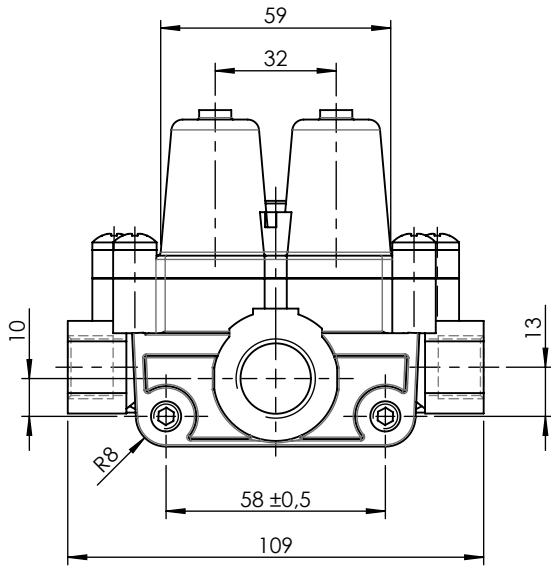

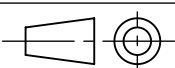
F	Modification	4				Drawn		F
		3				29/08/13 O.V.		
		2				Checked		
		1	J.S.	02/06/21	Change of sheet format	29/08/13 A.L.		
	n°	Modified	Date	Reason	General Tolerance	Assembly		
Comments					ISO 2768 c-K	Part name	Protection circuit valve	
					Material	ID. Reference	2222435	
					-	Scale: 1/2		Sheet 2/2
					-	Review: 1		