

**Technical sheet / Datos técnicos:**

Part number adaptable to / Referencia adaptable a	4613072000
Operating pressure / Presión de trabajo	max. 8 bar
Predominance / Predominancia	≤ 0,25 bar
Permissible medium / Medio de funcionamiento	Air / Aire
Operating temperature range / Rango de temperatura	-40 °C to / a +80 °C
Weight / Peso	3250 gr

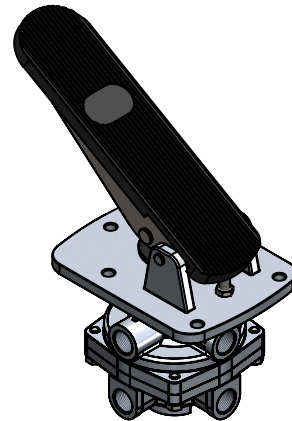
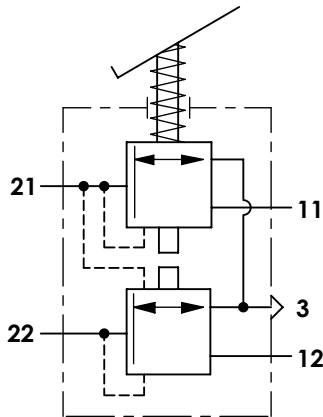

Port / Conexión	Function / Función	Thread / Rosca
11	Supply / Alimentación	M22x1,5
12	Supply / Alimentación	M22x1,5
21	Delivery / Salida	3x M22x1,5
22	Delivery / Salida	3x M22x1,5
3	Exhaust / Escape	-

**Purpose / Propósito:**

Application of service brake system through the pedal actuation by the driver. / Aplicación del freno de servicio mediante la actuación del pedal por parte del conductor.

**Installation requirements / Requisitos para la instalación:**

The design of the foot brake valve, acting on seat, must guarantee the maximum way of the push rod that is necessary to control the valve even in case of failure in the circuit I. Mounting is accomplished with three of five holes Ø9,5 mm. / El diseño de la válvula de freno de pie, accionándolo desde el asiento, debe garantizar el máximo recorrido de la varilla de empuje que resulta necesario para el accionamiento de la válvula, incluso en caso de que falle el circuito I. El montaje se efectúa mediante tres de los cinco agujeros Ø9,5 mm.

Modification	4				Drawn		
	3				29/06/17 J.S.		
	2				Checked		
	1				29/06/17 O.V.		
	nº	Modified	Date	Reason	General Tolerance		Assembly
Comments					-	Part name	Foot brake valve
					Material	ID. Reference	2212101
					-	Scale: -	
					-	Review: 0	

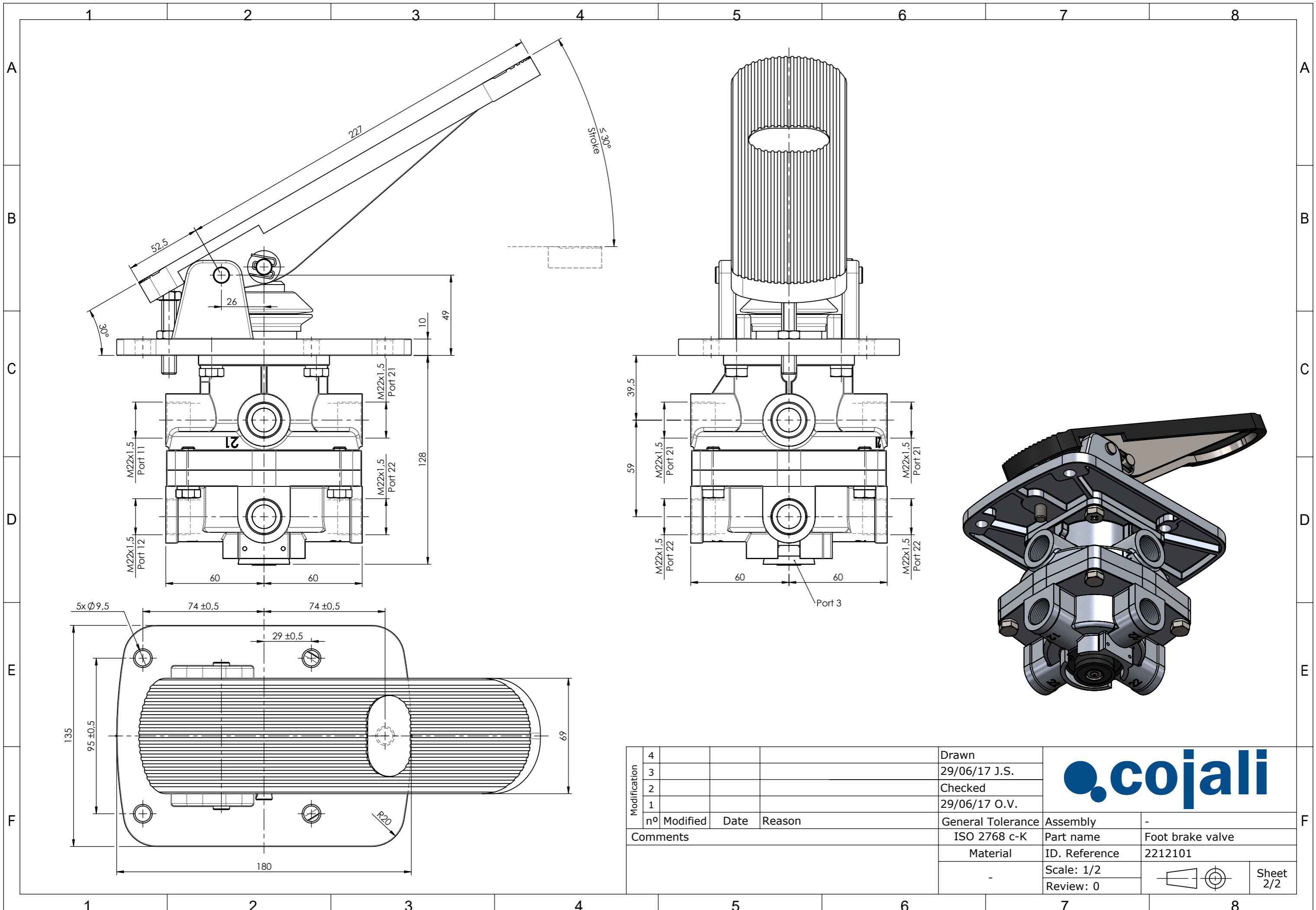

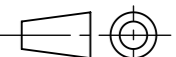
Modification	4			Drawn	
	3			29/06/17 J.S.	
	2			Checked	
	1			29/06/17 O.V.	
	nº Modified	Date	Reason	General Tolerance	Assembly
Comments				ISO 2768 c-K	Part name
				Material	ID. Reference
				-	Scale: 1/2
					Review: 0
					
				Sheet 2/2	