

1

2

3

4

A

Technical sheet / Datos técnicos:

A

Part number adaptable to / Referencia adaptable a	4342080270
Working pressure / Presión de trabajo	max 10 bar
Permissible medium / Medio de funcionamiento	Air / Aire
Operating temperature range / Rango de temperatura	-40 °C to / a +80 °C
Weight / Peso	140 gr

B

B

C

C

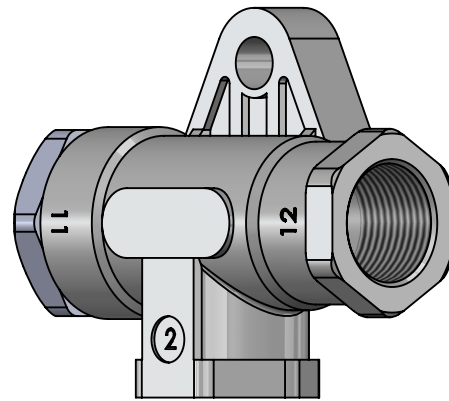
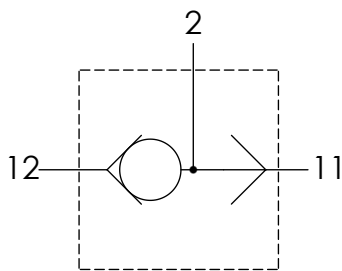

D

D

Port / Conexión	Function / Función	Thread / Rosca
11	Supply / Alimentación	M22x1.5
12	Supply / Alimentación	M22x1.5
2	Delivery / Salida	M22x1.5

Purpose / Propósito: Differential protection of the outlet pressure depending on the maximum pressure in the supply ports. / Protección diferencial de la presión de salida dependiendo de la máxima presión en las bocas de alimentación.

E

E

Installation requirements / Requisitos para la instalación: A hole is available for Screw M8. The working position is unimportant. / Se dispone de un orificio para tornillo M8. La posición de trabajo es indiferente.

F

F

Modification	4				Drawn			
	3				27/11/14 A.L-S.			
	2				Checked			
	1				27/11/14 A.L.			
	nº	Modified	Date	Reason	General Tolerance		Assembly	-
Comments					-	Part name	Double check valve	
					Material	ID. Reference	2207114	
					-	Scale: -		Sheet 1/2
					-	Review: 0		

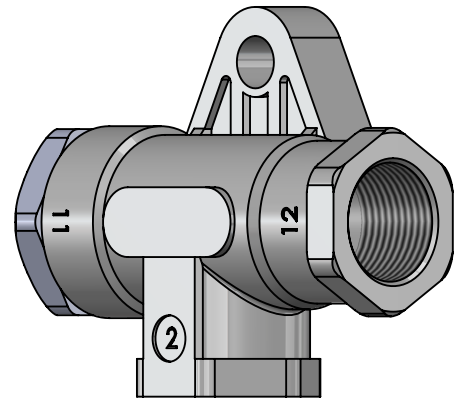
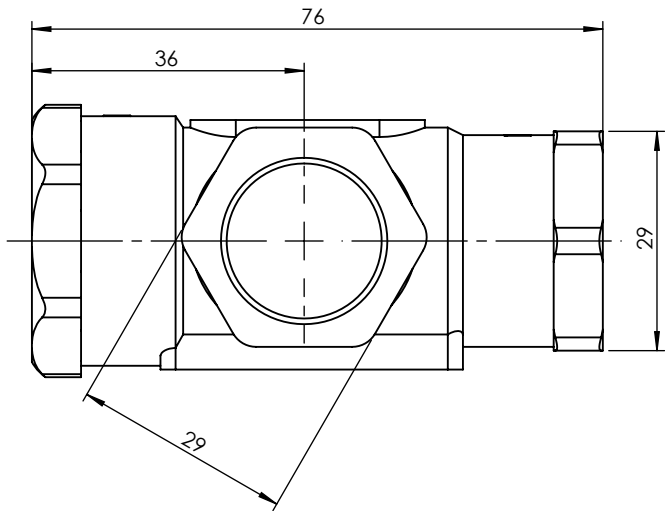
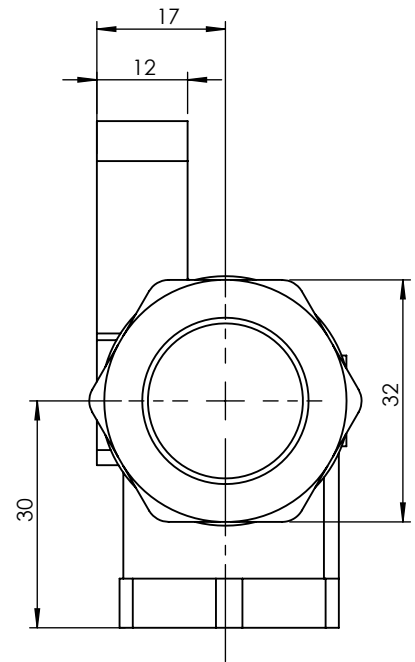
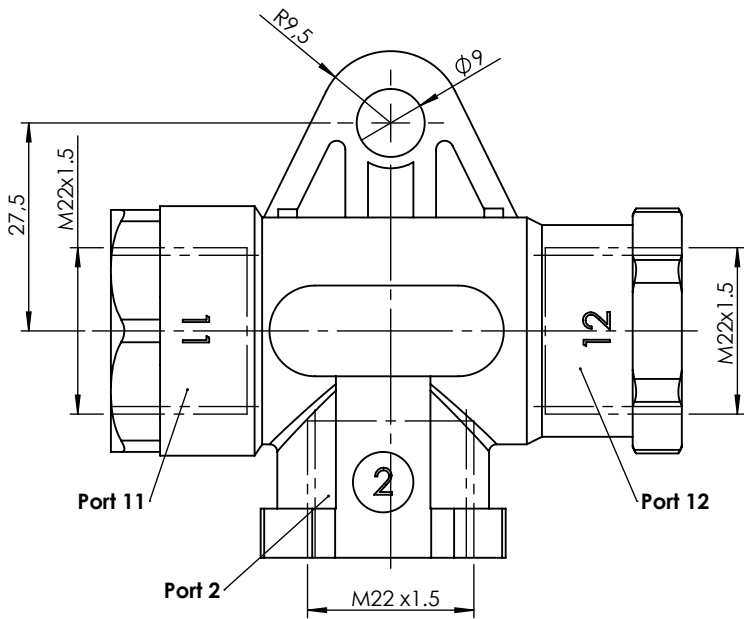

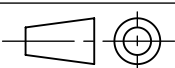
F	Modification	4				Drawn		F
		3				27/11/14 A.L-S.		
		2				Checked		
		1				27/11/14 A.L.		
	nº	Modified	Date	Reason	General Tolerance	Assembly		
Comments					ISO 2768 c-K	Part name	Double check valve	
					Material	ID. Reference	2207114	
					-	Scale: 1/1		Sheet 2/2
					-	Review: 0		