

1

2

3

4

Technical sheet / Datos técnicos:

Part number adaptable to / Referencia adaptable a	4721950430
Working pressure / Presión de trabajo	max 10 bar
Type of current / Tipo de corriente	Direct current/ Corriente continua
Voltage / Voltaje	24 V
Nominal current / Corriente nominal	1.65 A
Permissible medium / Medio de funcionamiento	Air / Aire
Operating temperature range / Rango de temperatura	-40 °C to / a +80 °C
Weight / Peso	2460 gr

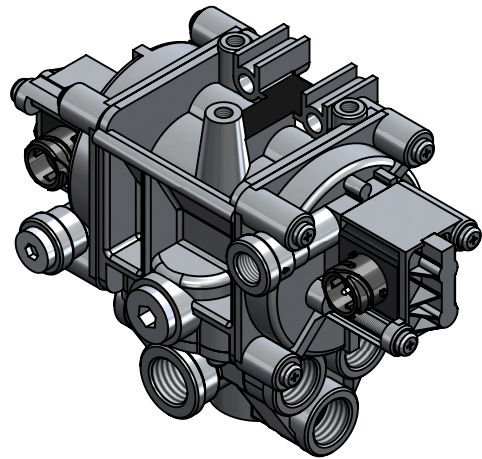
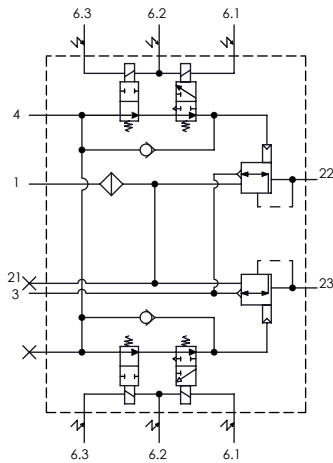

Port / Conexión	Function / Función	Thread / Rosca
1	Supply / Alimentación	M22x1.5
22	Delivery / Salida	3x M22x1.5
23	Delivery / Salida	3x M22x1.5
3	Exhaust / Escape	-
4	Control / Pilotaje	M16x1.5
6	Connector / Conector	2x DIN 72585 A1-3.1-Sn/K1

Purpose / Propósito: Increase, reduce or maintain the pressure in the brake cylinders during a braking process according to the regulation of the ABS electronic control unit. / Aumentar, reducir o mantener la presión en los cilindros de freno durante un proceso de frenado según la regulación de la unidad de control electrónico ABS.

Installation requirements / Requisitos para la instalación: To install the modulator with the exhaust port facing downwards. The modulator must be installed using two screws M8. / Instalar el modulador con el escape orientado hacia abajo. el modulador debe ser instalado utilizando dos tornillos M8.

Modification	4				Drawn			
	3				16/09/14 A.U.			
	2				Checked			
	1				16/09/14 A.L.			
	nº	Modified	Date	Reason	General Tolerance		Assembly	-
Comments					-	Part name	ABS modulator	
					Material	ID. Reference	2209215	
					-	Scale: -		Sheet 1/2
					-	Review: 0		

